

NAUTITECH®

HARNESSING TECHNOLOGY TO KEEP MINERS SAFE



CUBEx PS12

Intrinsically Safe 9-Output Universal Power Supply



Scan QR Code for
more on the PS12

nautitech.com.au

SYSTEM OVERVIEW

The CUBEx PS12 – Intrinsically Safe Universal Power Supply is universally compatible with Nautitech® and 3rd party certified Intrinsically Safe products such as lights, cameras, logic controllers, ethernet switches, sensors, alarms, and wireless access nodes.

Externally mounted directly into hazardous areas, the PS12 does not need to be installed in an Ex d enclosure freeing up valuable space for other items.

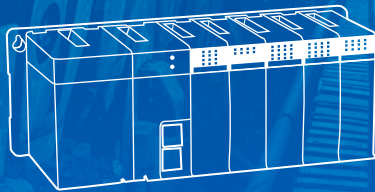

IS Logic Controllers

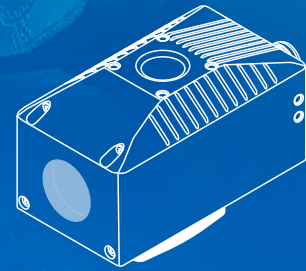

IS Cameras

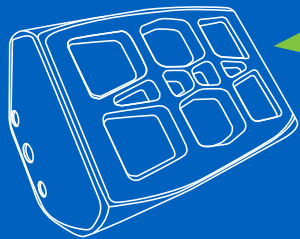

IS Lights

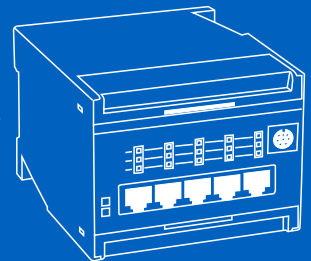

IS Ethernet Switches

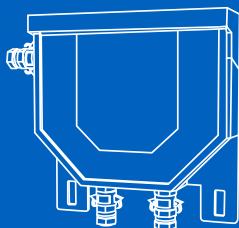

IS Wireless Access Nodes

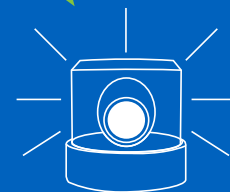

IS Sensors and Alarms

SYSTEM APPLICATIONS

A key advantage of the PS12 is that it can be externally mounted – freeing up real estate and minimising the internal temperature of a flameproof enclosure.

A single PS12 can replace up to FOUR Intrinsically Safe power supplies currently on the market and its universal compatibility means it can power up IS certified devices such as IS Cameras, IS Lights, IS Wireless Access Nodes, IS Logic Controllers, IS Ethernet Switches as well as IS Sensors and Alarms.

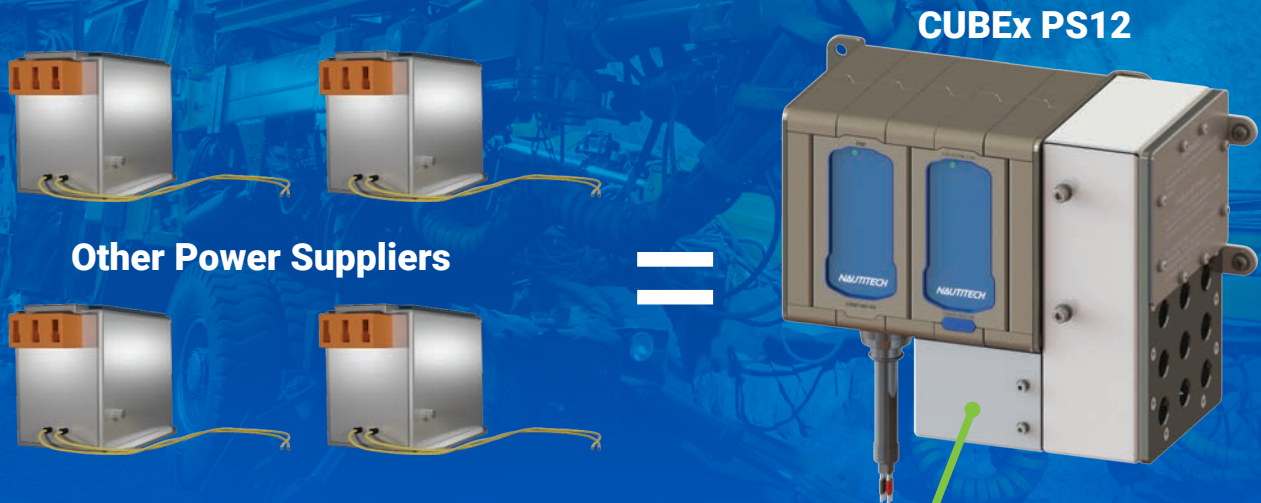

The PS12 is ideal for a wide range of underground mining applications including continuous miners, shuttle cars, feeder breakers, roof bolters, longwall equipment and other mobile machinery.

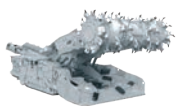

Continuous Miner



Shuttle Car



Feeder Breaker



Roof Bolter



C9 Diesel



Longwall



Loader



Man Transporter

SYSTEM SCHEMATIC

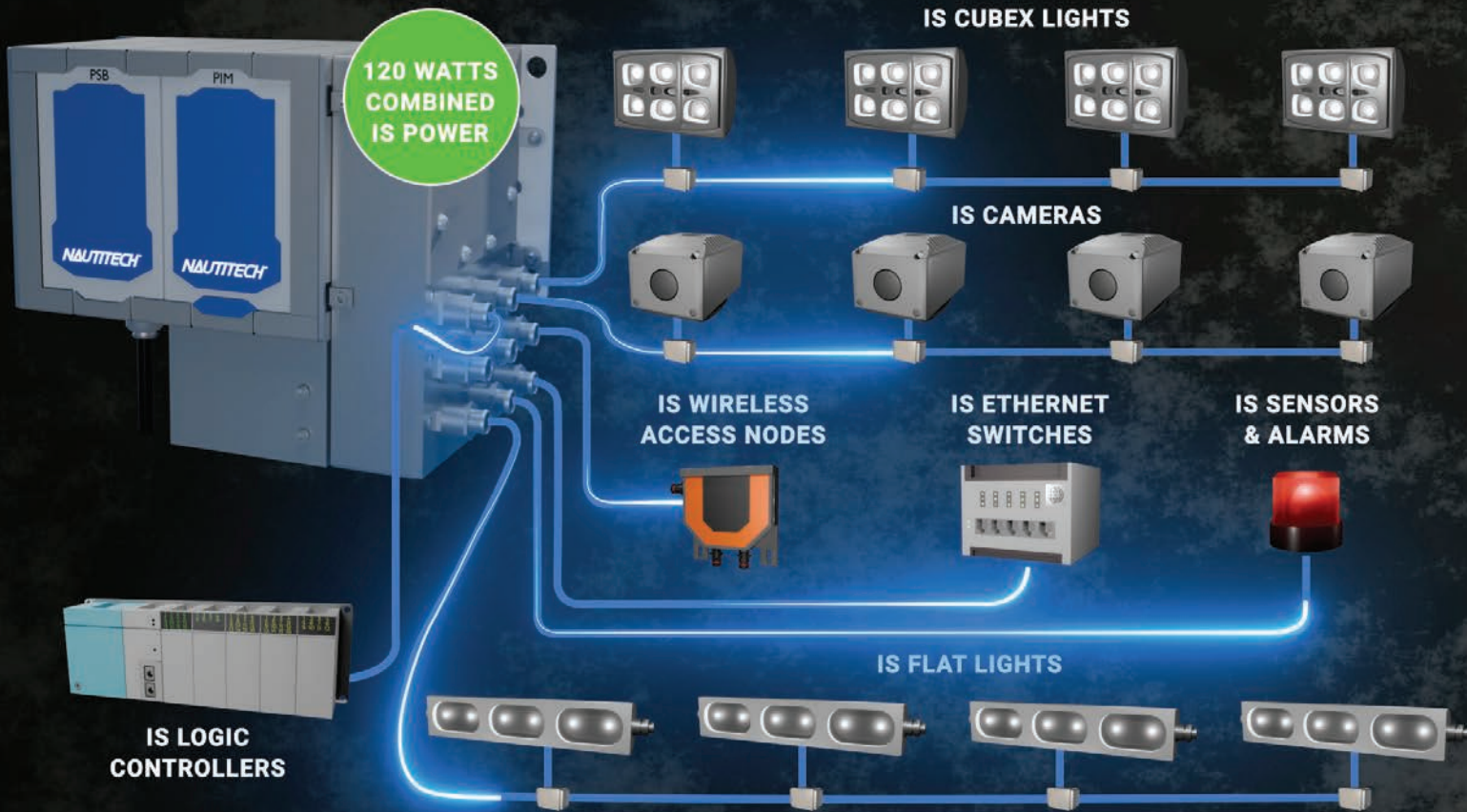

KEY FEATURES



- **12V CONTROLLABLE I.S. POWER SUPPLY**
- **UNIVERSAL COMPATIBILITY:**
Nautitech® and 3rd party certified products
- **VOLTAGE:** 12V controllable outputs
- **OUTPUT POWER:**
9 X 12V Up to 2.5A or 2.8A each
- **TOTAL COMBINED I.S. POWER:** 120W
- **PROGRAMMABLE:** via Bluetooth
- **INSTALLATION:**
Directly into hazardous areas. Externally mounted, no FLP enclosures required

Entity Parameters (PSB)

Outputs	9 X 12V I.S. outputs powering 17 controllable output channels
GPIOs	13 X I.S. configurable GPIOs
Input Power	10-30 VDC
Circuit In:	Um < 90V
Circuit Out:	Um < 90V
SUITABLE FOR:	12V and 24V Alternators
AMBIENT TEMP:	-20°C to +60°C

Entity Parameters (PIM 2.5A)

No. Circuits	9
Uo	13V
Io	2.5A
Co	7.7uF
Lo	99.3uH

Entity Parameters (PIM 2.8A)

No. Circuits	9
Uo	13V
Io	2.8A
Co	3.0uF
Lo	50.0uH

The values of Lo and Co will be reduced to 50% if both the following conditions are met:

- The total Li of the external circuit (excluding the cable) \geq 1% of the Lo value
 - The total Ci of the external circuit (excluding the cable) \geq 1% of the Co value.
- The reduced capacitance of the external circuit (including cable) will not be greater than 1uF

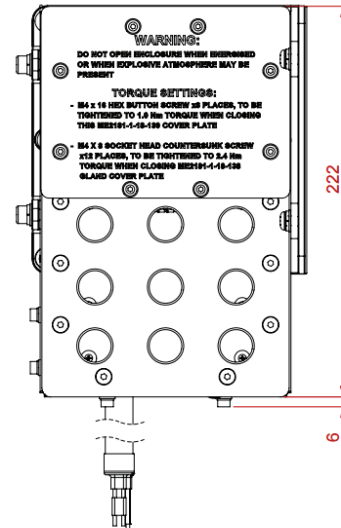
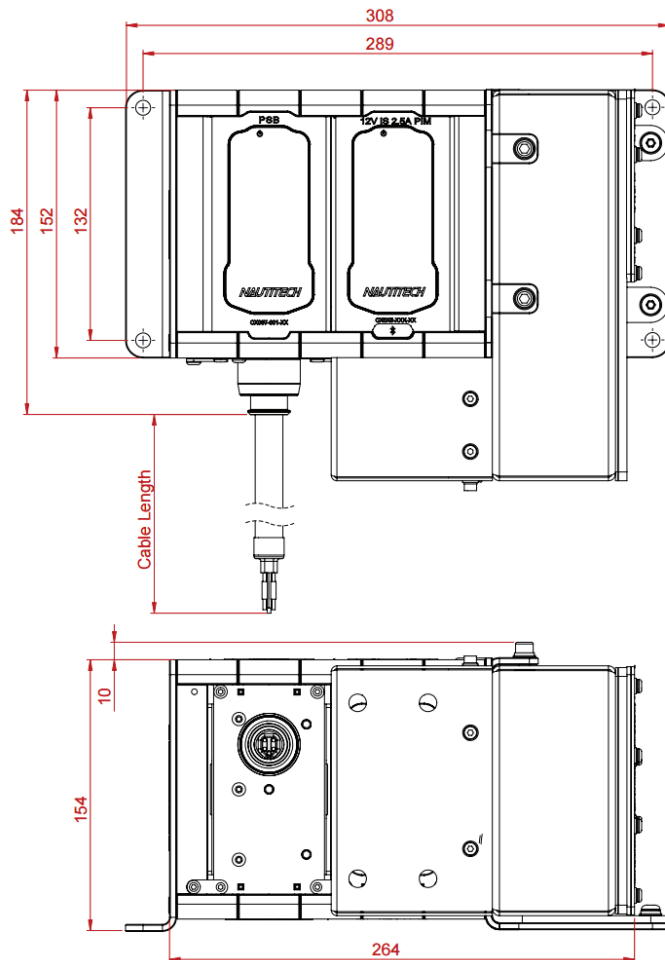

Ingress Protection

IP66	Enclosure-Top
IP56	JDRC-40 side connector with seal

CERTIFICATION

STANDARDS:	IEC 60079 Electrical apparatus for explosive gas atmospheres
PIM PROTECTION:	<ul style="list-style-type: none"> Increased Safety "eb" Intrinsic Safety "ib"
PIM MARKING:	Ex eb [ib] I Mb

PSM PROTECTION:	<ul style="list-style-type: none"> Encapsulation "mb" Increased Safety "eb" Intrinsic Safety "ia"
PSM MARKING:	<ul style="list-style-type: none"> Ex eb mb [ia] I Mb (Um available) Ex ia I Ma (Um withdrawn)



NAUTITECH®

HARNESSING TECHNOLOGY TO KEEP MINERS SAFE

NAUTITECH® is an Original Technology Manufacturer (OTM), and global provider of **smart electronic** and **software** solutions for OEMs and mine sites in underground mining.

We design and manufacture equipment that delivers **Communications** and **Visibility**, supports **Automation**, and provides a platform for **Asset and Condition Monitoring** of underground equipment. Our **data analytics** software can help detect safety risks and gain intelligence for improved mining operations.



South Africa

Middelburg, Mpumalanga
South Africa

+ 27 78 800 2589

sales_za@nautitech.com.au



New South Wales

3/9 Packard Avenue
Castle Hill, NSW 2154

+ 61 2 9899 6857

+ 61 417 711 018

sales@nautitech.com.au



Queensland

14 John Vella Drive
Paget, QLD 4740

+ 61 7 4911 4171

+ 61 400 268 755

sales@nautitech.com.au

Scan QR Code to discover our range of products and services

